

RECOMMENDED PCB LAYOUT
GENERAL TOLERANCE ±0.05

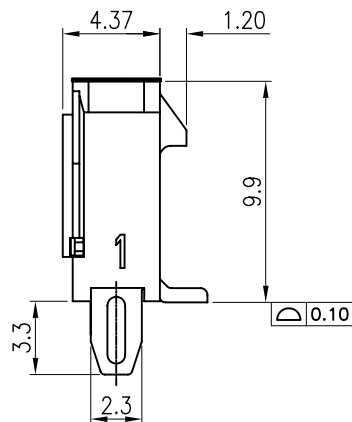
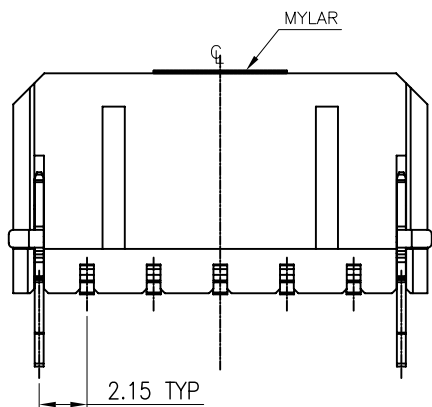
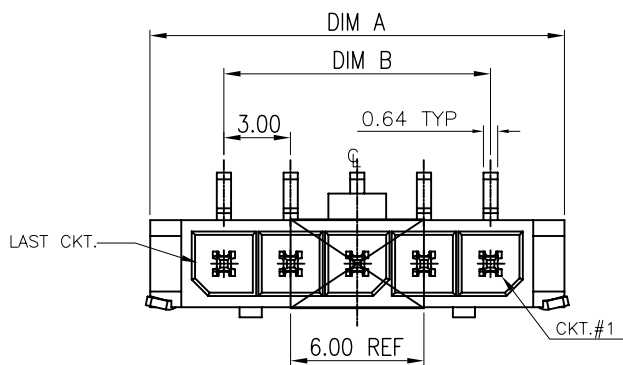

NOTES:

1. MATERIAL:
 - 1.1 HOUSING: THERMOPLASTIC, HIGH TEMP., UL94V-0; COLOR:BLACK.
 - 1.2 CONTACT: COPPER ALLOY
 - 1.3 FITTING NAIL: COPPER ALLOY
2. FINISH:
 - 2.1 CONTACT:
 - 50u" MIN. NICKEL UNDERPLATING OVERALL
 - N:60u" MIN MATTE TIN OVERALL
3. REFER TO PS-57957-XXXXX-XXX
4. PACKAGE PLS. REFER TO 5XXXX-XXXXX-XX-TRP
5. PART NUMBER

52996-XXX X X-002
 NO OF CKT ———— 002:NORMAL
 PACKING ———— PLATING N:MATTE TIN
 0:Tape & Reel
 4:Tape & Reel with Mylar

CKT	DIM A	DIM B	DIM C	M/Y size
2	9.65	3.00	14.20	
3	12.65	6.00	17.20	
4	15.65	9.00	20.20	W6T12-52996
5	18.65	12.00	23.20	
6	21.65	15.00	26.20	
7	24.65	18.00	29.20	
8	27.65	21.00	32.20	
9	30.65	24.00	35.20	
10	33.65	27.00	38.20	
11	36.65	30.00	41.20	
12	39.65	33.00	44.20	

QUALITY SYMBOLS MAJOR CRITICAL	DRAWN BY Wu Xiao Guang	DATE 18/08/10	
	CHECKED BY Lu Jing Quan	DATE 18/08/10	
GENERAL TOLERANCES (UNLESS SPECIFIED) X. ±0.5 .X ±0.25 .XX ±0.15 .XXX ±0.1 ANGLES ±2°	APPROVED BY hsieh fu yu	DATE 18/08/10	TITLE 3.0mm PITCH WTB HEADER CONN. SMT S/R S/T TYPE
	UNITS mm		SIZE A4
SCALE 3:1	SHEET NO. 1 OF 2	REV 0	PART NO. SEE NOTES

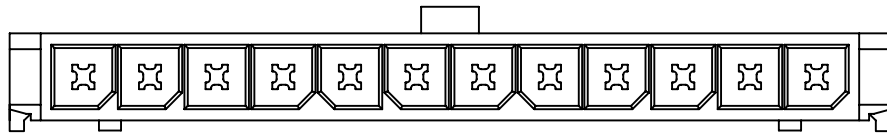

12-CKT

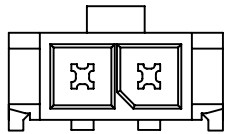

2-CKT

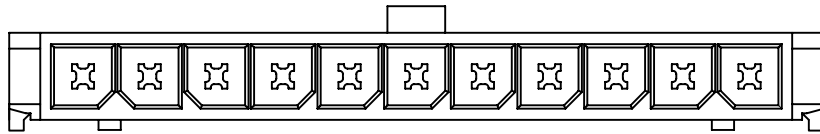

11-CKT

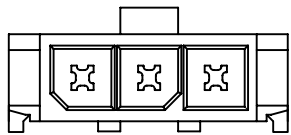

3-CKT

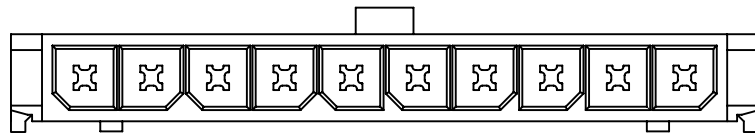

10-CKT

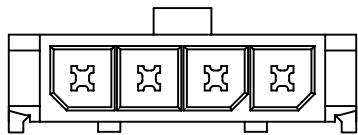

4-CKT

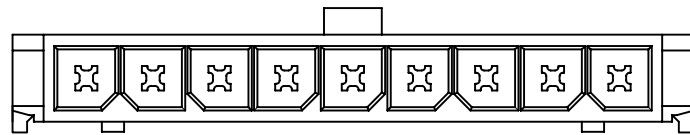

9-CKT

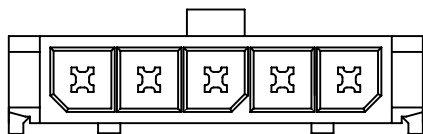

5-CKT

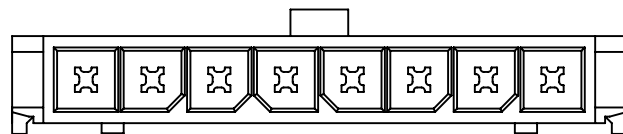

8-CKT

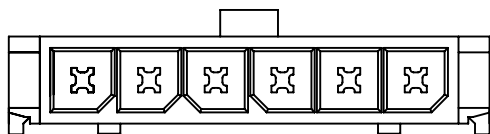

6-CKT

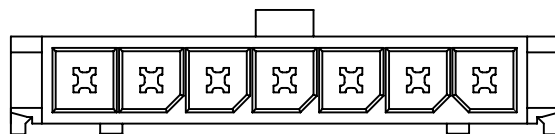

7-CKT

QUALITY SYMBOLS MAJOR CRITICAL GENERAL TOLERANCES (UNLESS SPECIFIED) X. ±0.5 .X ±0.25 .XX ±0.15 .XXX ±0.1 ANGLES ±2°	DRAWN BY Wu Xiao Guang	DATE 18/08/10	
	CHECKED BY Lu Jing Quan	DATE 18/08/10	
	APPROVED BY hsieh fu yu	DATE 18/08/10	SIZE A4
	UNITS mm		DWG NO. 52996-XXXXX-002
	SCALE 3:1	SHEET NO. 2 OF 2	REV 0
			PART NO. SEE NOTES